

Input side

Bus side

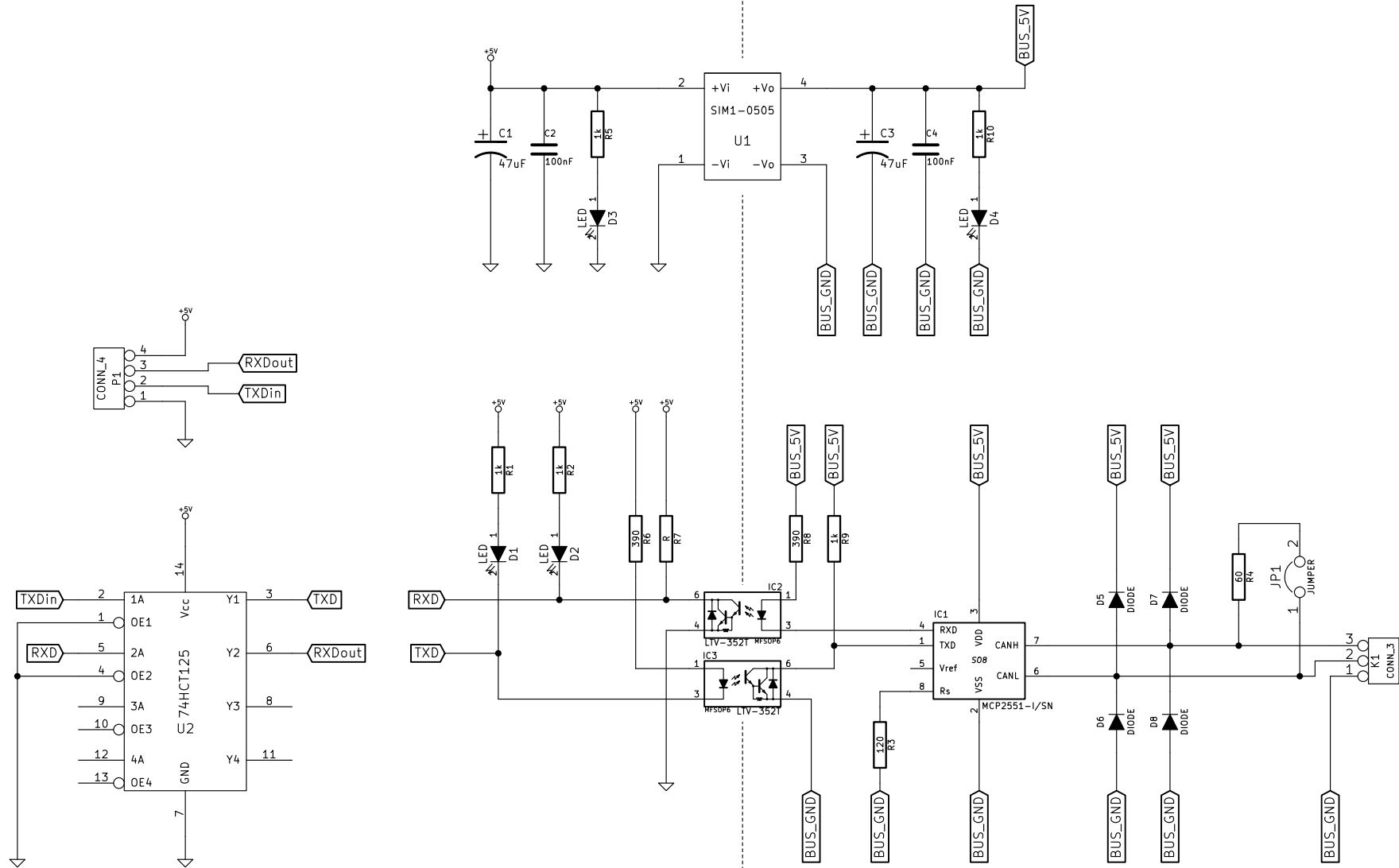

Telebørken	
File: sss7modem.sch	
Sheet: /	
Title: Seidenstrasse Signaling System 7 Modem	
Size: A4	Date: 21 may 2015
KiCad E.D.A.	Rev: 0.2
	Id: 1/1